

DATA SHEET

Product Name High Resistance Thick Film Chip Resistors

Part Name 0603/0805/1206/1210 Series

Uniroyal Electronics Global Co., Ltd.

88 Longteng Road, Economic & Technical Development Zone, Kunshan, Jiangsu, China

Tel +86 512 5763 1411 / 22 /33

Email marketing@uni-royal.cn

Manufacture Plant Uniroyal Electronics Industry (kunshan) co., ltd.
Uniroyal Electronics Industry Co., Ltd.
Uniroyal Electronics Global Co.,Ltd Shenzhen Branch
Aeon Technology Corporation
Uniroyal Electronics Global Co.,Ltd Xiamen Branch
Kunshan Foss Electronic material Co., Ltd.

Brands *RoyalOhm* *UniOhm*



1. Scope

- 1.1 This specification for approve relates to the High Resistance Thick Film Chip Resistors manufactured by UNI-ROYAL.
- 1.2 Suitable for reflow & wave soldering
- 1.3 Application AV adapters , LCD back-light camera strobe etc.

2. Part No. System

Part No. includes 14 codes shown as below:

2.1 1st~4th codes: Part name. E.g.: 01005, 0201, 0402, 0603, 0805, 1206 ,1210, 2010,1812, 2512.

2.2 5th~6th codes: Power rating.

E.g.: W=Normal Size	"1~G" = "1~16"									
Wattage	1/32	3/4	1/2	1/3	1/4	1/8	1/10	1/16	1/20	1
Normal Size	WH	07	W2	W3	W4	W8	WA	WG	WM	1W

If power rating is lower or equal than 1 watt, 5th code would be "W" and 6th code would be a number or letter.

E.g.: WA=1/10W W4=1/4W

2.3 7th code: Tolerance. E.g.: D=±0.5% F=±1% G=±2% J=±5% K= ±10%

2.4 8th~11th codes: Resistance Value.

2.4.1 If value belongs to standard value of ≥5% series, 8th code would be zero, 9th~10th codes are significant figures of the resistance and 11th code is the power of ten.

2.4.2 If value belongs to standard value of ≤2% series, 8th~10th codes are significant figures of the resistance, and 11th code is the power of ten.

2.4.3 11th codes listed as following:

0=10⁰ 1=10¹ 2=10² 3=10³ 4=10⁴ 5=10⁵ 6=10⁶ J=10⁻¹ K=10⁻² L=10⁻³ M=10⁻⁴

2.5 12th~14th codes.

2.5.1 12th code: Packaging Type. E.g.: C=Bulk T=Tape/Reel

2.5.2 13th code: Standard Packing Quantity.

4=4000pcs 5=5000pcs C=10000pcs D=20000pcs E=15000pcs

Chip Product: BD=B/B-20000pcs TC=T/R-10000pcs

2.5.3 14th code: Special features.

E = Environmental Protection, Lead Free, or Standard type.

3. Ordering Procedure:

(Example: 0805 1/8W ±5% 10KΩ T/R-5000)

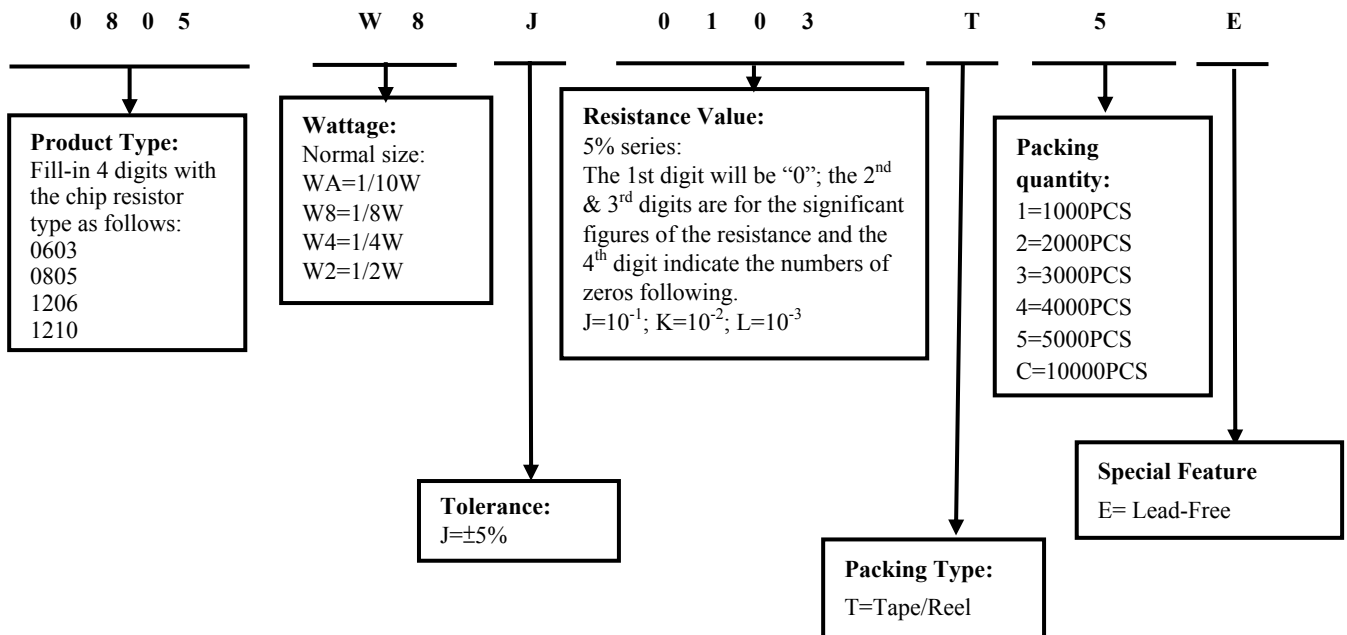

4. Marking

(1) ±5% Tolerance: The first two digits are significant figures of resistance and the third denotes number of zeros following



333 → 33KΩ

5. Dimension

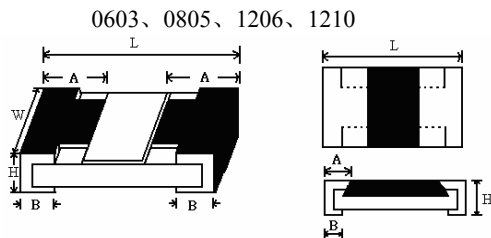

Type	Dimension(mm)				
	L	W	H	A	B
0603	1.60±0.10	0.80±0.10	0.45±0.10	0.30±0.20	0.30±0.20
0805	2.00±0.15	1.25+0.15/-0.10	0.55±0.10	0.40±0.20	0.40±0.20
1206	3.10±0.15	1.55+0.15/-0.10	0.55±0.10	0.45±0.20	0.45±0.20
1210	3.10±0.10	2.60±0.20	0.55±0.10	0.50±0.25	0.50±0.20

6. Ratings

Type	Max. Working Voltage	Max. Overload Voltage	Dielectric withstanding Voltage	Operating Temperature	Resistance Range 5%
0603	75V	150V	300V	-55°C~155°C	10M~100M
0805	150V	300V	500V	-55°C~155°C	10M~100M
1206	200V	400V	500V	-55°C~155°C	10M~100M
1210	200V	500V	500V	-55°C~155°C	10M~100M

7. Recommend the size of welding plate

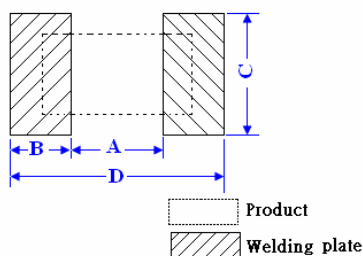

Type	Dimension(mm)			
	A	B	C	D
0603	0.9±0.05	0.65±0.05	0.8±0.05	2.1±0.05
0805	1.0±0.1	1.0±0.1	1.3±0.1	3.0±0.1
1206	2.0±0.1	1.1±0.1	1.6±0.1	4.2±0.1
1210	2.0±0.1	1.1±0.1	2.6±0.1	4.2±0.1

8. Derating Curve

Resistors shall have a power rating based on continuous load operation at an ambient temperature from -55°C to 70°C. For temperature in excess of 70°C, the load shall be derated as shown in figure 1

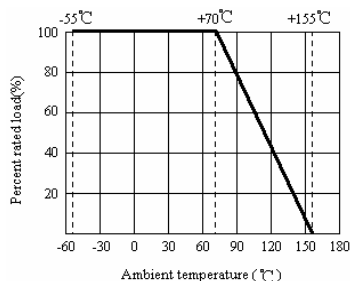

Voltage rating:

Resistors shall have a rated direct-current (DC) continuous working

voltage or an approximate sine-wave root-mean-square (RMS) alternating-current (AC) continuous working voltage at commercial-line frequency and waveform corresponding to the power rating, as determined from the following formula:

$$RCWV = \sqrt{P \times R}$$

Where: RCWV commercial-line frequency and waveform (Volt.)

P = power rating (WATT.) R = nominal resistance (OHM)

In no case shall the rated DC or RMS AC continuous working voltage be greater than the applicable maximum value.

The overload voltage is 2.5 times RCWV or Max. Overload voltage whichever is less

9. Structure

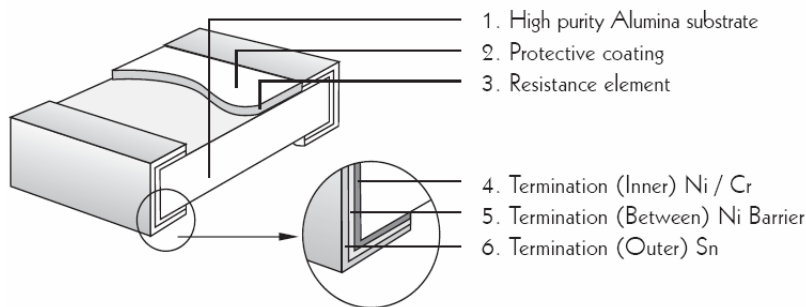

10. Performance Specification

Characteristic	Limits	Test Method (JIS-C-5201& JIS-C-5202)
Temperature Coefficient	±200PPM/°C	4.8 Natural resistance changes per temp. Degree centigrade $\frac{R_2-R_1}{R_1(t_2-t_1)} \times 10^6 \text{ (PPM/°C)}$ $\frac{R_3-R_1}{R_1(t_3-t_1)} \times 10^6 \text{ (PPM/°C)}$ R ₁ : Resistance Value at room temperature (t ₁) ; R ₂ : Resistance Value at upper limit temperature ± 2°C (t ₂) R ₃ : Resistance Value at lower limit temperature ± 3°C (t ₃) Test pattern : Room temperature : (t ₁) Upper limit temperature : (t ₂) Lower limit temperature : (t ₃)
Short-time overload	±(2%+0.1Ω) Max.	4.13 Permanent resistance change after the application of a potential of 2.5 times RCWV or Max. Overload Voltage whichever less for 5 seconds..
Dielectric withstanding voltage	No evidence of flashover mechanical damage, arcing or insulation breaks down.	4.7 Resistors shall be clamped in the trough of a 90°metallic v-block and shall be tested at ac potential respectively specified in the given list of each product type for 60-70 seconds.
Solderability	95% coverage Min.	Wave solder: Test temperature of solder: 245°C±3°C dipping time in solder: 2-3 seconds.
	Go up tin rate bigger than half of end pole	Reflow:
Rapid change of temperature	±(3%+0.1Ω)Max	4.19 30 min at lower limit temperature and 30 min at upper limit temperature , 5 cycles
Soldering heat	Resistance change rate is: ±(1%+0.05Ω) Max	4.18 Dip the resistor into a solder bath having a temperature of 260°C±5°C and hold it for 10±1 seconds.
Terminal bending	±(1%+0.05Ω) Max	4.33 Twist of test board: Y/X = 3/90 mm for 60Seconds
Insulation resistance	1,000 MΩ or more	4.6 The measuring voltage shall be ,measured with a direct voltage of (100 ±15)V or a voltage equal to the dielectric withstanding voltage., and apply for 1min.
Humidity (steady state)	±(3.0%+0.1Ω) Max.	4.24Temporary resistance change after 240 hours exposure in a humidity test chamber controlled at 40±2°C and 90-95% relative humidity,

Load life in humidity	$\pm(3\%+0.1\Omega)\text{Max.}$	7.9 Resistance change after 1,000 hours (1.5 hours “ON”, 0.5 hour “OFF”) at RCWV in a humidity chamber controlled at 40 °C \pm 2°C and 90 to 95% relative humidity.
Load life	$\pm(3\%+0.1\Omega)\text{Max}$	4.25.1 Permanent resistance change after 1,000 hours operating at RCWV with duty cycle 1.5 hours “ON”, 0.5 hour “OFF” at 70 °C \pm 2°C ambient.
Low Temperature Storage	$\pm(3\%+0.1\Omega)\text{Max}$	4.23.4 Lower limit temperature , for 2H.
High Temperature Exposure	$\pm(3\%+0.1\Omega)\text{Max}$	4.23.2 Upper limit temperature , for 16H.
Leaching	No visible damage	J-STD-002 Test D Samples completely immersed for 30 sec in solder bath at 260°C

11. Packing of Surface Mount Resistors

11.1 Dimension of Paper Taping :(Unit: mm)

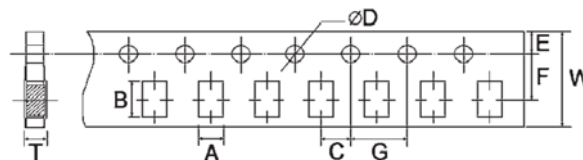

Type	A ± 0.2	B ± 0.2	C ± 0.05	ΦD $\begin{matrix} +0.1 \\ -0 \end{matrix}$	E ± 0.1	F ± 0.05	G ± 0.1	W ± 0.2	T ± 0.1
0603	1.10	1.90	2.00	1.50	1.75	3.50	4.00	8.00	0.67
0805	1.65	2.40	2.00	1.50	1.75	3.50	4.00	8.00	0.81
1206	2.00	3.60	2.00	1.50	1.75	3.50	4.00	8.00	0.81
1210	2.80	3.50	2.00	1.50	1.75	3.50	4.00	8.00	0.75

11.2 Dimension of Reel : (Unit: mm)

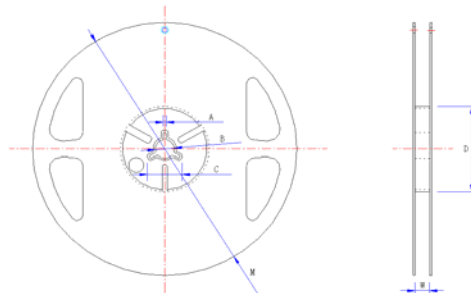

Type	Taping	Qty/Reel	A ± 0.5	B ± 0.5	C ± 0.5	D ± 1	M ± 2	W ± 1
0603	Paper	5,000pcs	2.0	13.0	21.0	60.0	178.0	10.0
0805	Paper	5,000pcs	2.0	13.0	21.0	60.0	178.0	10.0
1206	Paper	5,000pcs	2.0	13.0	21.0	60.0	178.0	10.0
1210	Paper	5,000pcs	2.0	13.0	21.0	60.0	178.0	10.0

12. Note

- 12.1. UNI-ROYAL recommend the storage condition temperature: 15°C~35°C, humidity :25%~75%.
(Put condition for individual product).Even under UNI-ROYAL recommended storage condition, solderability of products over 1 year old.
(Put condition for each product) may be degraded.
- 12.2. Store / transport cartons in the correct direction, which is indicated on a carton as a symbol.
Otherwise bent leads may occur due to excessive stress applied when dropping of a carton.
- 12.3. Product performance and soldered connections may deteriorate if the products are stored in the following places:
- Storage in high Electrostatic.
 - Storage in direct sunshine 、rain and snow or condensation.
 - Where the products are exposed to sea winds or corrosive gases, including Cl₂, H₂S₃, NH₃, SO₂, NO₂.
- 12.4. The products are used in circuit board thickness greater than 1.6mm. If customers use less than the thickness of the circuit board that you should confirm with the company, in order to recommend a more suitable product.

13. Record

Version	Description of amendment	Page	Date	Amended by	Checked by
1	First issue of this specification	1~6	Mar.20, 2018	Chen Haiyan	Chen Nana

Uniroyal Electronics Global Co., Ltd. , all rights reserved. Spec. herein would be changed at any time without prior notice.