

DATA SHEET

Product Name AEC-Q200 Version Chip Resistors

Part Name HQ Series

Uniroyal Electronics Global Co., Ltd.

88 Longteng Road, Economic & Technical Development Zone, Kunshan, Jiangsu, China

Tel +86 512 5763 1411 / 22 /33

Email marketing@uni-royal.cn

Manufacture Plant Uniroyal Electronics Industry (kunshan) co., ltd.
Uniroyal Electronics Industry Co., Ltd.
Uniroyal Electronics Global Co.,Ltd Shenzhen Branch
Aeon Technology Corporation
Uniroyal Electronics Global Co.,Ltd Xiamen Branch
Kunshan Foss Electronic material Co., Ltd.

Brands *RoyalOhm* *UniOhm*



1. Scope

- 1.1 This specification for approve relates to the AEC-Q200 Version Chip Resistors manufactured by UNI-ROYAL.
- 1.2 Suitable for reflow & wave soldering
- 1.3 Application car

2. Explanation of Part No. System

Part No. includes 14 codes shown as below:

- 2.1 1st~4th codes: Part name. E.g.: HQ02,HQ03,HQ05,HQ06,HQ07,HQ10,HQ12
- 2.2 5th~6th codes: Power rating.

E.g.: W=Normal Size "1~G" = "1~16"

Wattage	1/32	3/4	1/2	1/3	1/4	1/8	1/10	1/16	1/20	1
Normal Size	WH	07	W2	W3	W4	W8	WA	WG	WM	1W

If power rating is lower or equal than 1 watt, 5th code would be "W" and 6th code would be a number or letter.

E.g.: WA=1/10W W4=1/4W

2.3 7th code: Tolerance. E.g.: D=±0.5% F=±1% G=±2% J=±5% K= ±10%

2.4 8th~11th codes: Resistance Value.

2.4.1 If value belongs to standard value of ≥5% series, 8th code would be zero, 9th~10th codes are significant figures of the resistance and 11th code is the power of ten.

2.4.2 If value belongs to standard value of ≤2% series, 8th~10th codes are significant figures of the resistance, and 11th code is the power of ten.

2.4.3 11th codes listed as following:

$$0=10^0 \quad 1=10^1 \quad 2=10^2 \quad 3=10^3 \quad 4=10^4 \quad 5=10^5 \quad 6=10^6 \quad J=10^{-1} \quad K=10^{-2} \quad L=10^{-3} \quad M=10^{-4}$$

2.5 12th~14th codes.

2.5.1 12th code: Packaging Type. E.g.: C=Bulk T=Tape/Reel

2.5.2 13th code: Standard Packing Quantity.

4=4000pcs 5=5000pcs C=10000pcs D=20000pcs E=15000pcs

Chip Product: BD=B/B-20000pcs TC=T/R-10000pcs

2.5.3 14th code: Special features.

E = Environmental Protection, Lead Free, or Standard type.

3. Ordering Procedure

(Example: HQ05 1/8W ±5% 10KΩ T/R-5000)

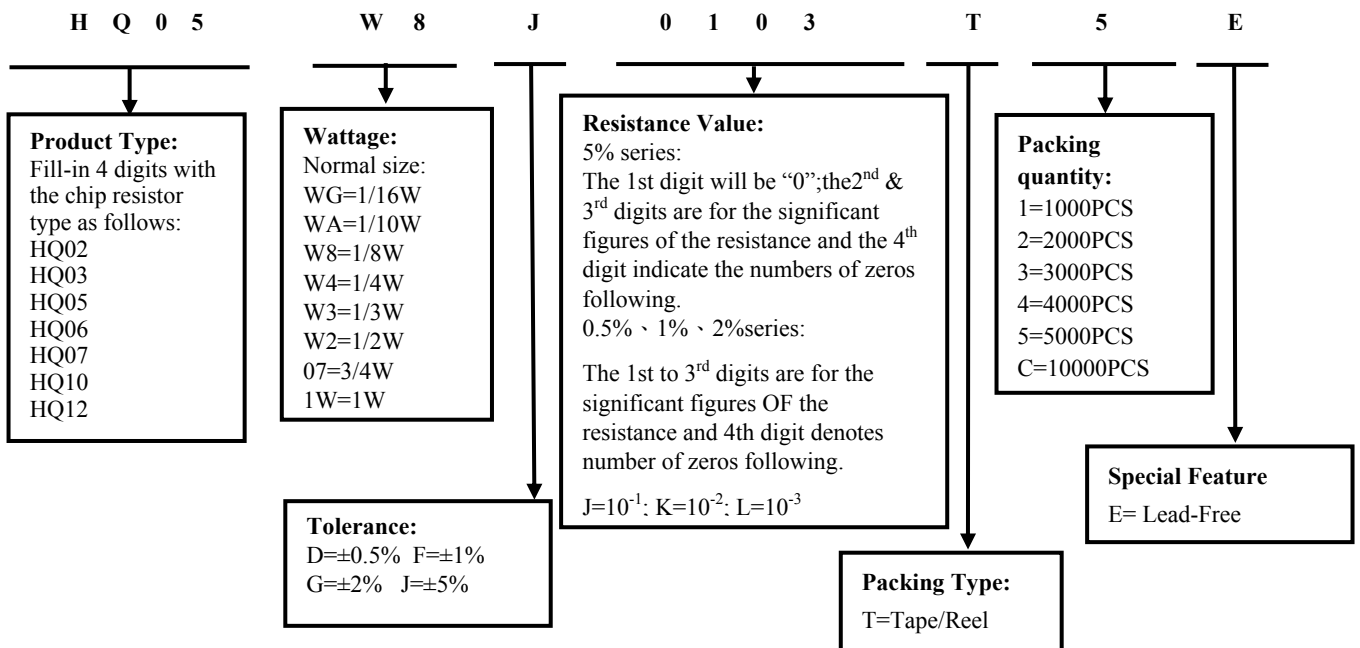

4. Marking

(1) For HQ02 size. Due to the very small size of the resistor's body, there is no marking on the body.
Example:



Normally, the making of 0Ω HQ03, 0Ω HQ05, 0Ω HQ06, 0Ω HQ07, 0Ω HQ10, 0Ω HQ12 resistors as following



(2) ±5% Tolerance: The first two digits are significant figures of resistance and the third denotes number of zeros following



(3) ±1% Tolerance: 4 digits, first three digits are significant; fourth digit is number of zeros. Letter r is decimal point.



(4) More than HQ05 specifications (including) 4 digits, Product below 1Ω, show as following, the first digit Is "R" which as decimal point.

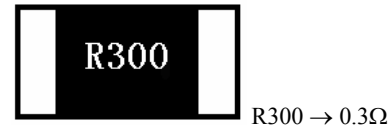

5. Dimension

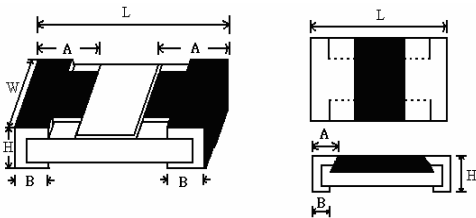

Type	Dimension(mm)				
	L	W	H	A	B
HQ02(0402)	1.00±0.10	0.50±0.05	0.35±0.05	0.20±0.10	0.25±0.10
HQ03(0603)	1.60±0.10	0.80±0.10	0.45±0.10	0.30±0.20	0.30±0.20
HQ05(0805)	2.00±0.15	1.25+0.15/-0.10	0.55±0.10	0.40±0.20	0.40±0.20
HQ06(1206)	3.10±0.15	1.55+0.15/-0.10	0.55±0.10	0.45±0.20	0.45±0.20
HQ07(1210)	3.10±0.10	2.60±0.20	0.55±0.10	0.50±0.25	0.50±0.20
HQ10(2010)	5.00±0.10	2.50±0.20	0.55±0.10	0.60±0.25	0.50±0.20
HQ12(2512)	6.35±0.10	3.20±0.20	0.55±0.10	0.60±0.25	0.50±0.20

6. Resistance Range

Type	Power Rating at 70°C	Resistance Range	
		1.0%	5.0%
HQ02	1/16W	1Ω~10M	1Ω~10M
HQ03	1/10W	1Ω~10M	1Ω~10M
HQ05	1/8W	1Ω~10M	1Ω~10M
HQ06	1/4W	1Ω~10M	1Ω~10M
HQ07	1/3W	1Ω~10M	1Ω~10M
HQ10	3/4W	1Ω~10M	1Ω~10M
HQ12	1W	1Ω~10M	1Ω~10M

7. Ratings

Type	Max. Working Voltage	Max. Overload Voltage	Dielectric withstanding Voltage	Resistance Value of Jumper	Rated Current of Jumper	Max. Overload Current of Jumper	Operating Temperature
HQ02	50V	100V	100V	<50mΩ	1A	2A	-55°C~155°C
HQ03	75V	100V	300V	<50mΩ	1A	2A	-55°C~155°C
HQ05	150V	300V	500V	<50mΩ	2A	5A	-55°C~155°C
HQ06	200V	400V	500V	<50mΩ	2A	10A	-55°C~155°C
HQ07	200V	500V	500V	<50mΩ	2A	10A	-55°C~155°C
HQ10	200V	500V	500V	<50mΩ	2A	10A	-55°C~155°C
HQ12	200V	500V	500V	<50mΩ	2A	10A	-55°C~155°C

8. Recommend the size of welding plate

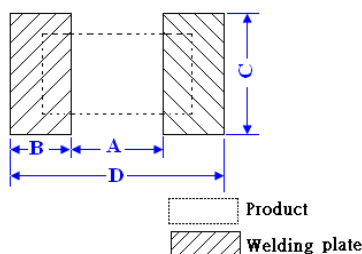

Type	Dimension(mm)			
	A	B	C	D
HQ02	0.5±0.05	0.5±0.05	0.6±0.05	1.5±0.05
HQ03	0.8±0.05	0.8±0.05	0.9±0.05	2.4±0.05
HQ05	1.0±0.1	1±0.1	1.4±0.1	3±0.1
HQ06	2.0±0.1	1.1±0.1	1.8±0.1	4.2±0.1
HQ07	2.0±0.1	1.1±0.1	2.9±0.1	4.2±0.1
HQ10	3.6±0.1	1.4±0.1	3±0.1	6.4±0.1
HQ12	4.9±0.1	1.35±0.1	3.7±0.1	7.6±0.1

9.0 Derating Curve

Resistors shall have a power rating based on continuousload operation at an ambient temperature from -55°C to 125°C.

For temperature in excess of 125°C, the load shall be derate as shown in figure 1

Figure 1

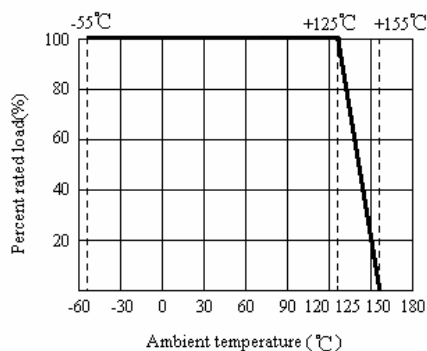

8.1 Voltage rating:

Resistors shall have a rated direct-current (DC) continuous working

Voltage or an approximate sine-wave root-mean-square (RMS) alternating-current (AC) continuous working voltage at commercial-line frequency and waveform corresponding to the power rating, as determined from the following formula:

$$RCWV = \sqrt{P \times R}$$

Where: RCWV commercial-line frequency and waveform (Volt.)

P = power rating (WATT.) R = nominal resistance (OHM)

In no case shall the rated DC or RMS AC continuous working voltage be greater than the applicable maximum value.

The overload voltage is 2.5 times RCWV or Max. Overload voltage whichever is less.

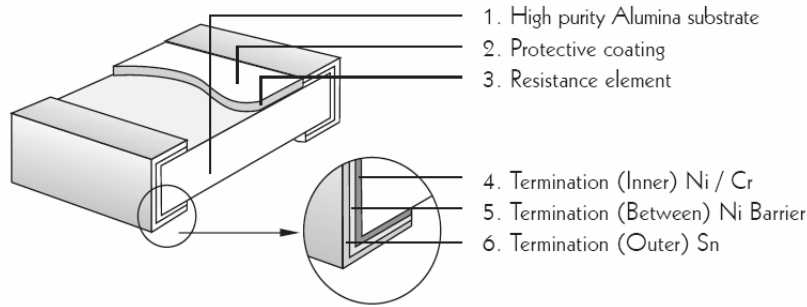
10. Structure

11. Performance Specification

Characteristic	Limits	Ref. Standards	Test Method
Operational life	$\pm 5\%: \pm(3\%+0.1\Omega)\text{Max.}$ $\pm 1\%: \pm(1\%+0.1\Omega)\text{Max.}$	MIL-STD-202 Method 108	125°C, at 100% of operating power, 1000H(1.5 hours "ON", 0.5 hour "OFF").
	<100mΩ		Apply to rate current for 0 Ω
Electrical Characterization	$1\Omega \leq R \leq 10\Omega: \leq \pm 400\text{PPM}/^\circ\text{C}$ $10\Omega < R \leq 100\Omega: \leq \pm 200\text{PPM}/^\circ\text{C}$ $100\Omega < R \leq 10\text{M}\Omega: \leq \pm 100\text{PPM}/^\circ\text{C}$	User Spec	Parametrically test per lot and sample size requirements, summary to show Min, Max, Mean and Standard deviation at room as well as Min and Max operating temperatures.
Short-time overload	$\pm 1\%: \pm(1\%+0.1\Omega)\text{Max.}$ $\pm 5\%: \pm(2\%+0.1\Omega)\text{Max.}$		4.13 Permanent resistance change after the application of a potential of 2.5 times RCWV or Max. Overload Voltage whichever less for 5 seconds..
External Visual	No Mechanical Damage	MIL-STD-883 Method 2009	Electrical test not required. Inspect device construction, marking and workmanship
Physical Dimension	Reference 5. Dimension Standards	JESD22 MH Method JB-100	Verify physical dimensions to the applicable device detail specification. Note: User(s) and Suppliers spec. Electrical test not required.
Resistance to Solvent	Marking Unsmearred	MIL-STD-202 Method 215	Note: Add Aqueous wash chemical – OKEM Clean or equivalent. Do not use banned solvents.
Terminal Strength	Not broken	JIS-C-6429	Force of 1.8kg for 60 seconds.
High Temperature Exposure (Storage)	$\pm(1\%+0.1\Omega)\text{Max.}$	MIL-STD-202 Method 108	1000hrs. @T=155 °C .Unpowered. Measurement at 24±2 hours after test conclusion.
	<50mΩ		Apply to rate current for 0 Ω
Temperature Cycling	$\pm(1\%+0.1\Omega)\text{Max.}$	JESD22 Method JA-104	1000 Cycles (-55°C to +155°C). Measurement at 24±2 hours after test conclusion.
	<50mΩ		Apply to rate current for 0 Ω
Biased Humidity	$\pm 5\%: \pm(3\%+0.1\Omega)\text{Max.}$ $\pm 1\%: \pm(1\%+0.1\Omega)\text{Max.}$	MIL-STD-202 Method 103	1000 hours 85°C, 85%RH. Note: Specified conditions: 10% of operating power. Measurement at 24±2 hours after test conclusion.
	<100mΩ		Apply to rate current for 0 Ω
Mechanical Shock	$\pm(1\%+0.1\Omega)\text{Max.}$	MIL-STD-202 Method 213	Wave Form: Tolerance for half sine shock pulse. Peak value is 100g's. Normal duration (D) is 6.
Vibration	$\pm(1\%+0.1\Omega)\text{Max.}$	MIL-STD-202 Method 204	5g's for 20 min., 12cycle each of 3 orientations. Note: Use 8"*5"PCB. 031" thick 7 secure points on one long side and 2 secure points at corners of opposite sides. Parts mounted within 2' from any secure point. Test from 10-2000Hz.

ESD	$\pm(1\%+0.1\Omega)\text{Max.}$	AEC-Q200-002	Test condition: HQ02: 0.5KV; HQ03: 1KV; HQ05:2KV; HQ06: 3KV; HQ07、HQ10、HQ12: 5KV
Soldrability	95% coverage Min.	J-STD-002	For both leaded & SMD. Electrical test not required. Magnification 50X. Conditions: a) Method B 4hrs at 155°C dry heat, the dip in bath with 245°C,5s. b) Method D: at 260°C, 60s.
Board Flex	$\pm(1\%+0.05\Omega)\text{Max.}$	JIS-C-6429	2mm (Min)
	$<50\text{m}\Omega$		Apply to rate current for 0 Ω
Resistance to Soldering Heat	$\pm(1\%+0.05\Omega)\text{Max.}$	MIL-STD-202 Method 210	Condition B No per-heat of samples. Note: Single Wave Solder-Procedure 2 for SMD and Procedure 1 for Leaded with solder within 1.5mm of device body.
	$<50\text{m}\Omega$		Apply to rate current for 0 Ω

Sulfuration test: H2S 3~5PPM 50°C±2°C 91%~93%RH 1000H ±5%:(5.0%+0.1 Ω)Max ; ±1%:(1.0%+0.1 Ω)Max

12. Packing of Surface Mount Resistors

12.1 Dimension of Paper Taping :(Unit: mm)

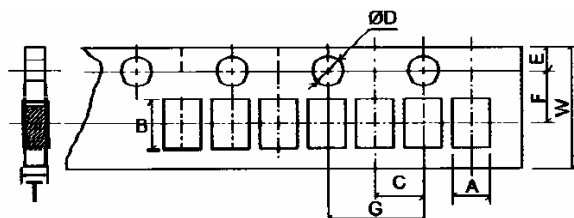

Type	A ±0.1	B ±0.1	C ±0.05	ΦD +0.1 -0	E ±0.1	F ±0.05	G ±0.1	W ±0.2	T ±0.05
HQ02	0.65	1.20	2.00	1.50	1.75	3.50	4.00	8.00	0.42

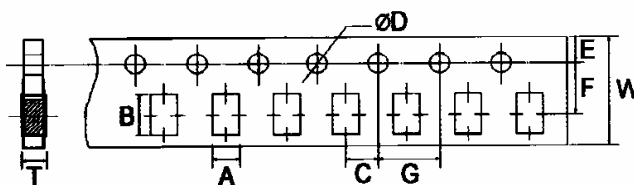

Type	A ±0.2	B ±0.2	C ±0.05	ΦD +0.1 -0	E ±0.1	F ±0.05	G ±0.1	W ±0.2	T ±0.1
HQ03	1.10	1.90	2.0	1.5	1.75	3.5	4.0	8.0	0.67
HQ05	1.65	2.40	2.0	1.5	1.75	3.5	4.0	8.0	0.81
HQ06	2.00	3.60	2.0	1.5	1.75	3.5	4.0	8.0	0.81
HQ07	2.80	3.50	2.0	1.5	1.75	3.5	4.0	8.0	0.75

12.2 Dimension of Embossed Taping:

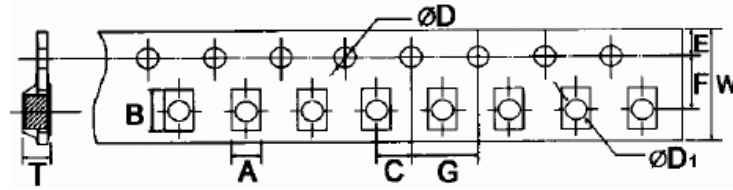

Type	A ±0.2	B ±0.2	C ±0.05	+0.1 φD - 0	+0.25 φD1 - 0	E ±0.1	F ±0.05	G ±0.1	W ±0.2	T ±0.1
HQ10	2.90	5.60	2.00	1.50	1.50	1.75	5.50	4.00	12.00	1.00
HQ12	3.50	6.70	2.00	1.50	1.50	1.75	5.50	4.00	12.00	1.00

12.3 Dimension of Reel : (Unit: mm)

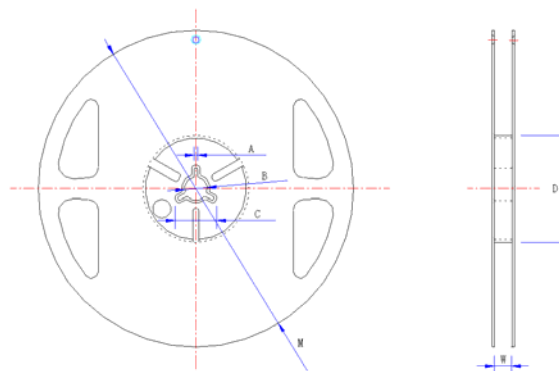

Type	Taping	Qty/Reel	A±0.5	B±0.5	C±0.5	D±1	M±2	W±1
HQ02	Paper	10,000pcs	2.0	13.0	21.0	60.0	178.0	10.0
HQ03	Paper	5,000pcs	2.0	13.0	21.0	60.0	178	10
HQ05	Paper	5,000pcs	2.0	13.0	21.0	60.0	178	10
HQ06	Paper	5,000pcs	2.0	13.0	21.0	60.0	178	10
HQ07	Paper	5,000pcs	2.0	13.0	21.0	60.0	178	10
HQ10	Embossed	4,000pcs	2.0	13.0	21.0	60.0	178	13.8
HQ12	Embossed	4,000pcs	2.0	13.0	21.0	60.0	178.0	13.8

13. **Note**

- 13.1. UNI-ROYAL recommend the storage condition temperature: 15°C~35°C, humidity :25%~75%.
(Put condition for individual product).Even under UNI-ROYAL recommended storage condition, solderability of products over 1 year old.
(Put condition for each product) may be degraded.
- 13.2. Store / transport cartons in the correct direction, which is indicated on a carton as a symbol.
Otherwise bent leads may occur due to excessive stress applied when dropping of a carton.
- 13.3. Product performance and soldered connections may deteriorate if the products are stored in the following places:
 - a. Storage in high Electrostatic.
 - b. Storage in direct sunshine 、rain and snow or condensation.

14. **Record**

Version	Description of amendment	Page	Date	Amended by	Checked by
1	First issue of this specification	1~7	Mar.20, 2018	Chen Haiyan	Chen Nana